



High Density Mounting Type Photocoupler

LTV816V/LTV826/LTV846

LTV816S/LTV826S/LTV846S

LTV816M/LTV826M/LTV846M

Features

- Current transfer ratio
(CTR : MIN. 50% at $I_F = 5\text{mA}$, $V_{CE} = 5\text{V}$)
- High input-output isolation voltage :
($V_{iso} : 5,000V_{rms}$)
- Compact dual-in-line package
LTV816 : 1-channel type
LTV826 : 2-channel type
LTV846 : 4-channel type
- UL approved in process
- Options Available :
 - Leads with 0.4" (10.16mm) Spacing (M Type)
 - Lead Bends for Surface Mounting (S Type)
 - Tape and Reel of Type I for SMD(Add"-TA"Suffix)
 - Tape and Reel of Type II for SMD(Add"-TA1"Suffix)
 - VDE 0884 Approvals (Add "-V" Suffix)

Applications

1. Programmable controllers, computers.
2. System appliances, measuring instruments.
3. Signal transmission between circuits of different potentials and impedances.

Package Dimensions

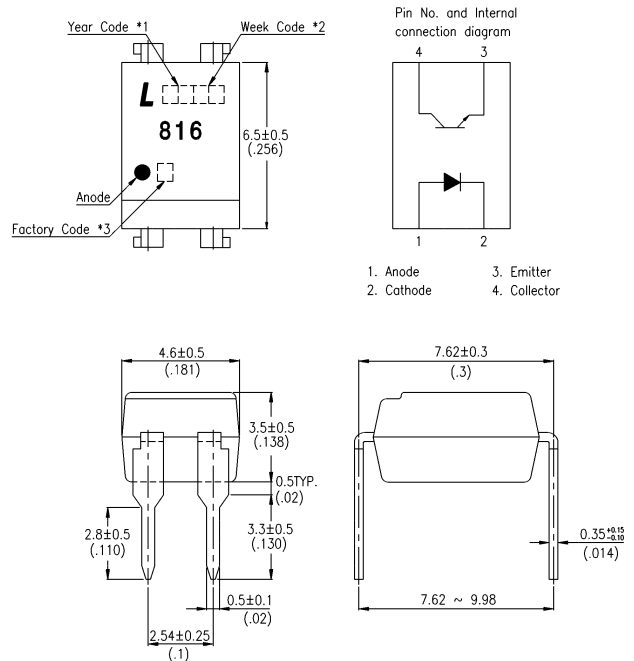

Notes :

1. Year date code.
2. 2-digit work week.
3. Factory code shall be marked (Z : Taiwan, Y : Thailand).
4. Rank shall be or shall not be marked.
5. All dimensions are in millimeters (inches).
6. Tolerance is $\pm 0.25\text{mm}$ (.010") unless otherwise noted.
7. Specifications are subject to change without notice.

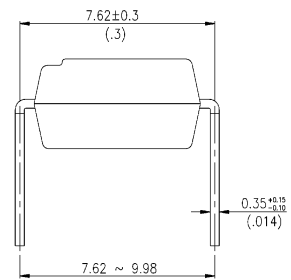
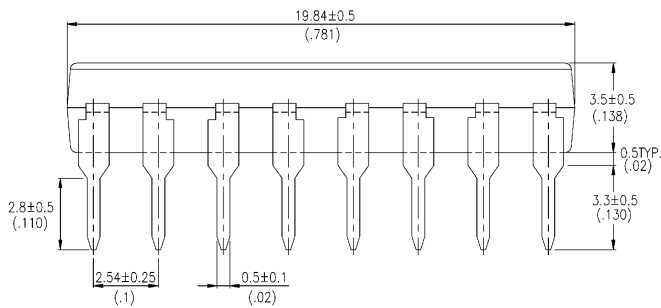
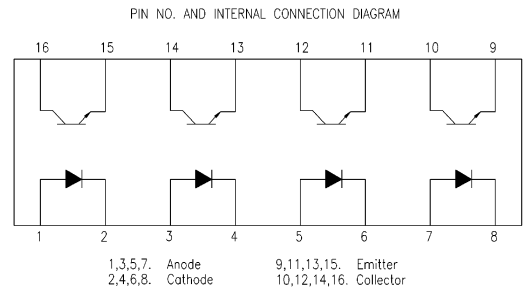
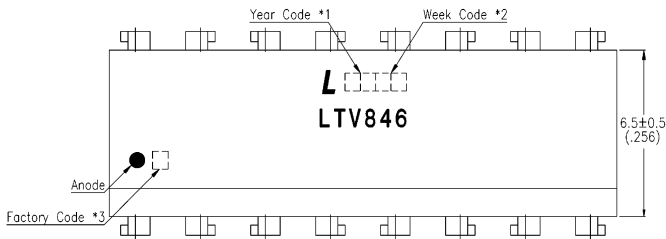
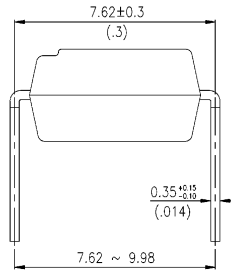
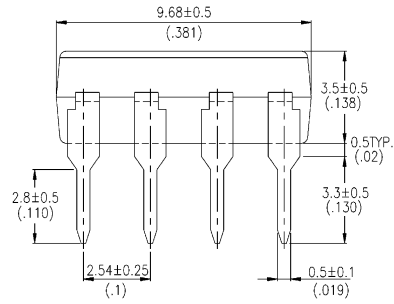
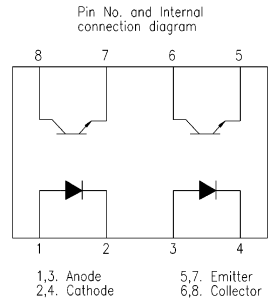
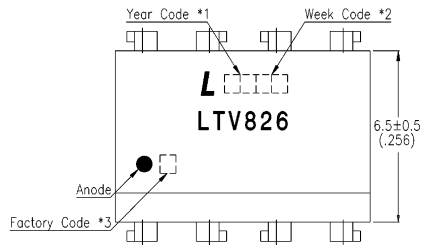

Absolute Maximum Ratings

(Ta=25 °C)

Parameter		Symbol	Rating	Unit
Input	Forward Current	IF	50	mA
	Reverse Voltage	VR	6	V
	Power Dissipation	P	70	mW
Output	Collector - Emitter Voltage	VCEO	80	V
	Emitter - Collector Voltage	VECO	6	V
	Collector Current	IC	50	mA
	Collector Power Dissipation	PC	150	mW
Total Power Dissipation		Ptot	200	mW
*1 Isolation Voltage		Viso	5,000	Vrms
Operating Temperature		Topr	-30 ~ +100	°C
Storage Temperature		Tstg	-55 ~ +125	°C
*2 Soldering Temperature		Tsol	260	°C

PHOTOCOUPLEDERS

* 1. AC for 1 minute, 40 ~ 60%R.H.

• Isolation voltage shall be measured using the following method.

(1) Short between anode and cathode on the primary side and between collector, emitter and base on the secondary side.

(2) The isolation voltage tester with zero-cross circuit shall be used.

(3) The waveform of applied voltage shall be a sine wave.

* 2. For 10 seconds.

Electrical/Optical Characteristics

(Ta=25 °C)

Parameter		Symbol	Min.	Typ.	Max.	Unit	Conditions
Input	Forward Voltage	V _F	—	1.2	1.4	V	I _F =20mA
	Reverse Current	I _R	—	—	10	μA	V _R =4V
	Terminal Capacitance	C _t	—	30	250	pF	V=0, f=KHz
Output	Collector Dark Current	I _{CEO}	—	—	100	nA	V _{CE} =20V
	Collector-Emitter Breakdown Voltage	BV _{CEO}	80	—	—	V	I _C =0.1mA
	Emitter-Collector Breakdown Voltage	BV _{ECO}	6	—	—	V	I _E =10μA
Transfer Characteristics	Collector Current	I _C	2.5	—	30	mA	I _F =5mA V _{CE} =5V
	*1 Current Transfer Ratio	CTR	50	—	600	%	
	Collector-Emitter Saturation Voltage	V _{CE(sat)}	—	0.1	0.2	V	I _F =20mA I _C =1mA
	Isolation Resistance	R _{iso}	5 × 10 ¹⁰	10 ¹¹	—	Ω	DC500V, 40 ~ 60%R.H.
	Floating Capacitance	C _f	—	0.6	1	pF	V=0, f=1MHz
	Cut-Off Frequency	f _c	—	80	—	kHz	V _{CE} =5V, I _C =2mA R _L =100 Ω, -3dB
	Response Time (Rise)	t _r	—	4	18	μS	V _{CE} =2V, I _C =2mA R _L =100 Ω
	Response Time (Fall)	t _f	—	3	18	μS	

* $CTR = \frac{I_C}{I_F} \times 100\%$

■ Supplement

Rank Table of Current Transfer Ratio CTR

Model No.	Rank Mark	CTR(%)
LTV-816 L	L	50~100
LTV-816 A	A	80~160
LTV-816 B	B	130~260
LTV-816 C	C	200~400
LTV-816 D	D	300~600
LTV-816	L or A or B or C or D	50~600

Conditions	$I_F=5\text{mA}$ $V_{CE}=5\text{V}$ $T_a=25\text{ }^\circ\text{C}$

Typical Electrical/Optical Characteristic Curves (25 °C Ambient Temperature Unless Otherwise Noted)

Fig.1 Forward Current Vs. Ambient Temperature

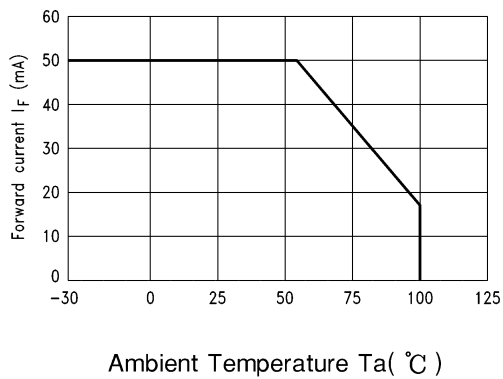

Fig. 2 Collector Power Dissipation Vs. Ambient Temperature

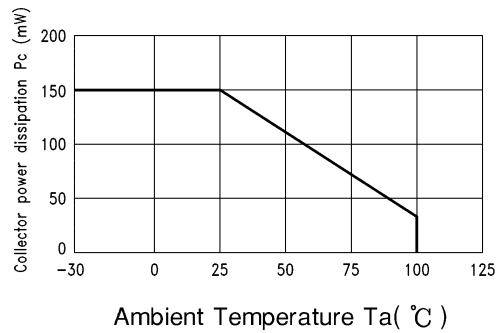

Fig. 3 Collector-Emitter Saturation Voltage Vs. Forward Current

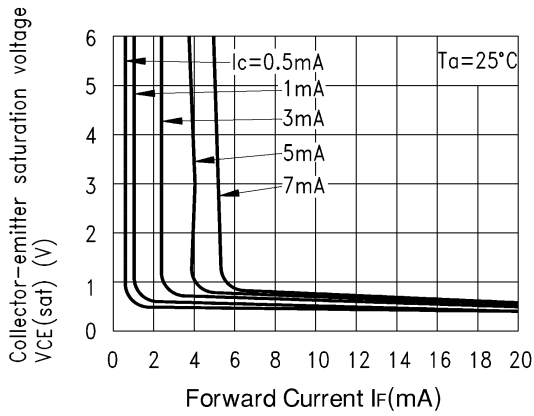

Fig. 4 Current Transfer Ratio Vs. Forward Current

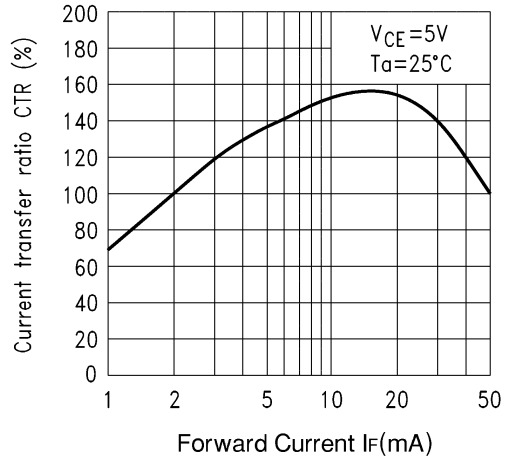

Fig. 5 Forward Current Vs. Forward Voltage

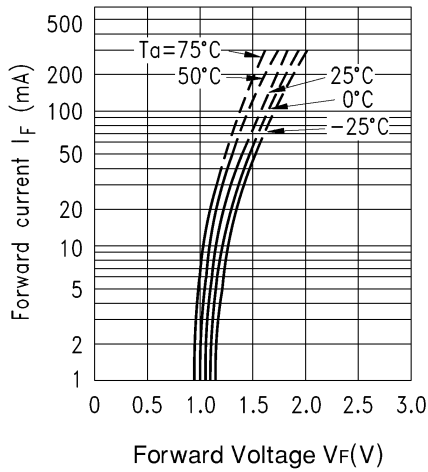

Fig. 6 Collector Current Vs. Collector-emitter Voltage

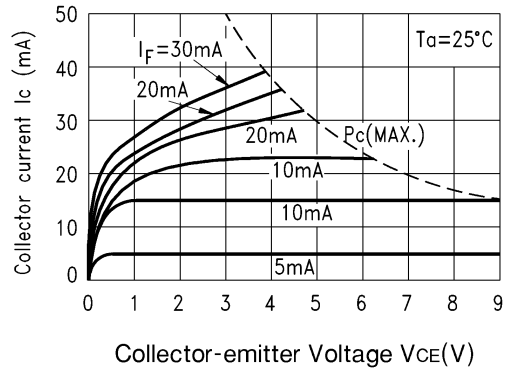

Fig. 7 Relative Current Transfer Ratio Vs. Ambient Temperature

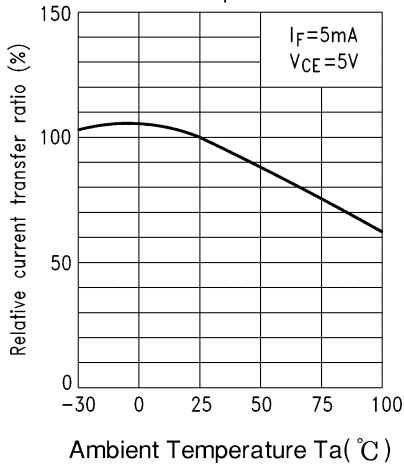

Fig. 8 Collector-emitter Saturation Voltage Vs. Ambient Temperature

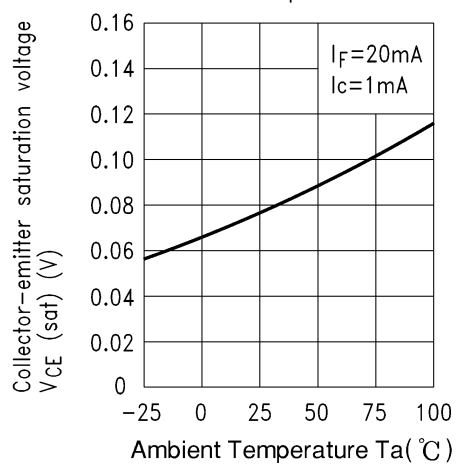

Fig. 9 Collector Dark Current Vs. Ambient Temperature

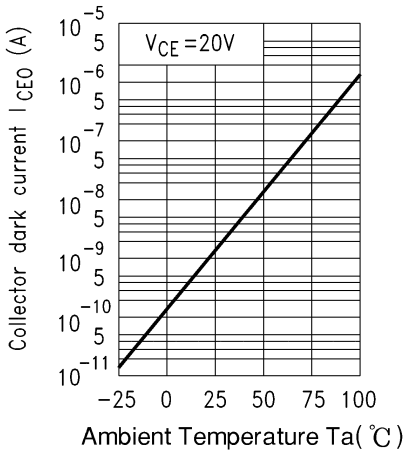

Fig. 10 Response Time Vs. Load Resistance

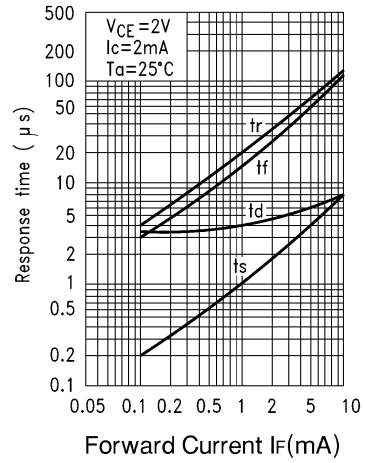
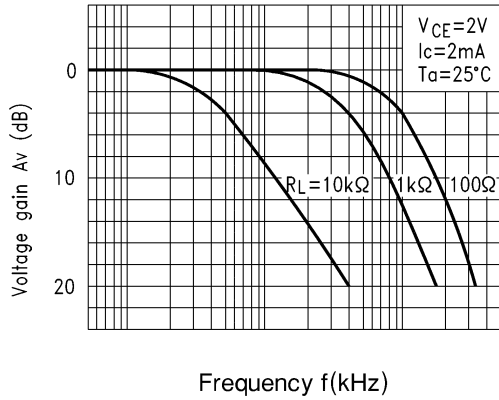
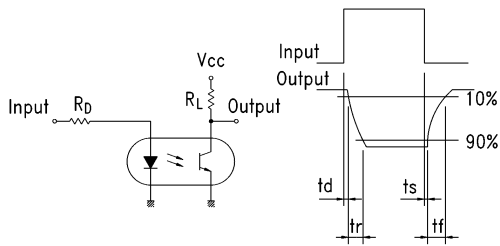

Fig. 11 Frequency Response



PHOTOCOUPPLERS

Test Circuit For Response Time



Test Circuit For Frequency Response

