

N-CHANNEL SILICON POWER MOS-FET

F-I SERIES

Features

- High speed switching
- Low on-resistance
- No secondary breakdown
- Low driving power
- High voltage

Applications

- Switching regulators
- UPS
- DC-DC converters
- General purpose power amplifier

Max. Ratings and Characteristics

Absolute Maximum Ratings(Tc=25°C)

Items	Symbols	Ratings	Units
Drain-source voltage	V_{DSS}	800	V
Continuous drain current	I_D	3	A
Pulsed drain current	$I_{D(puls)}$	12	A
Continuous reverse drain current	I_{DR}	3	A
Gate-source peak voltage	V_{GSS}	± 20	V
Max. power dissipation	P_D	40	W
Operating and storage temperature range	T_{ch}	150	°C
	T_{stg}	-55 ~ +150	°C

Electrical Characteristics(Tc=25°C)

Items	Symbols	Test Conditions	Min.	Typ.	Max.	Units
Drain-source breakdown voltage	$V_{(BR)DSS}$	$I_D = 1mA$ $V_{GS} = 0V$	800			V
Gate threshold voltage	$V_{GS(th)}$	$I_D = 10mA$ $V_{DS} = V_{GS}$	2.1	3.0	4.0	V
Zero gate voltage drain current	I_{DSS}	$V_{DS} = 800V$ $V_{GS} = 0V$ $T_{ch} = 25^\circ C$		10	500	μA
Gate-source leakage current	I_{GSS}	$V_{GS} = \pm 20V$ $V_{DS} = 0V$		10	100	nA
Drain-source on-state resistance	$R_{DS(on)}$	$I_D = 1.5A$ $V_{GS} = 10V$		3.0	4.0	Ω
Forward transconductance	g_{fs}	$I_D = 1.5A$ $V_{DS} = 25V$	2.0	4.0		S
Input capacitance	C_{iss}	$V_{DS} = 25V$		900	1400	pF
Output capacitance	C_{oss}	$V_{GS} = 0V$		90	140	
Reverse transfer capacitance	C_{rss}	$f = 1MHz$		35	60	
Switching time ($t_{off} = t_{d(off)} + t_r$)	t_{on}	$V_{CC} = 30V$ $R_G = 50\Omega$		60	90	ns
	$t_{d(off)}$	$I_D = 2.1A$		150	250	
	t_r	$V_{GS} = 10V$		60	90	
Diode forward on-voltage	V_{SD}	$I_F = 2 \times I_{DR}$ $V_{GS} = 0V$ $T_{ch} = 25^\circ C$		1.0	1.35	V
Reverse recovery time	t_{rr}	$I_F = I_{DR}$ $d_i/d_t = 100A/\mu s$ $T_{ch} = 25^\circ C$		400		ns

Thermal Characteristics

Items	Symbols	Test Conditions	Min.	Typ.	Max.	Units
Thermal Resistance	$R_{th(ch-a)}$	channel to air			62.5	°C/W
	$R_{th(ch-c)}$	channel to case			3.125	°C/W

Outline Drawings

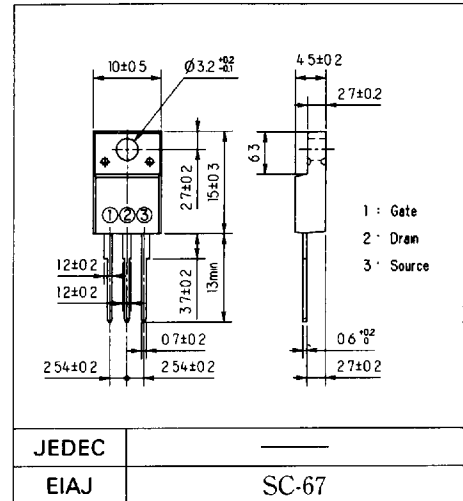

Equivalent Circuit Schematic

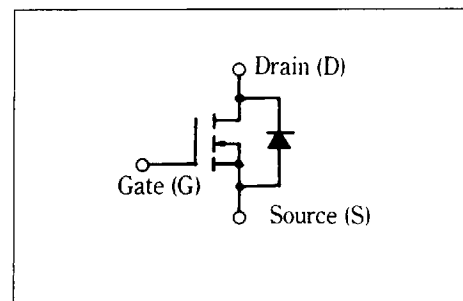

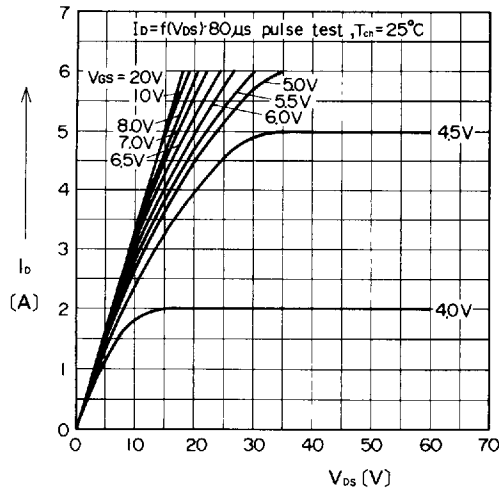

Typical Output Characteristics

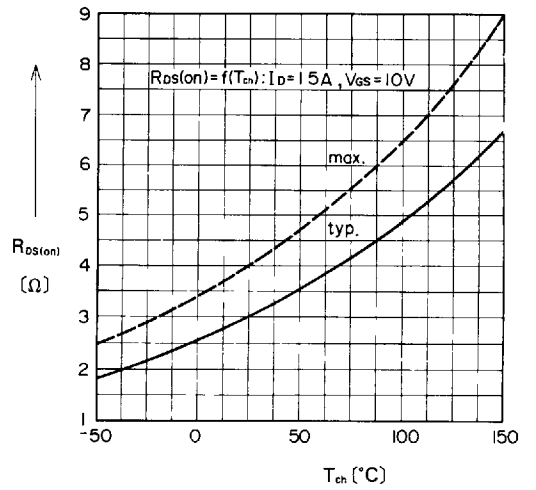

On State Resistance vs. T_{ch}

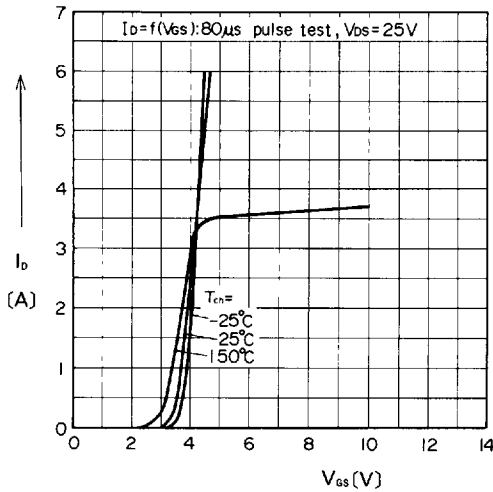

Typical Transfer Characteristic

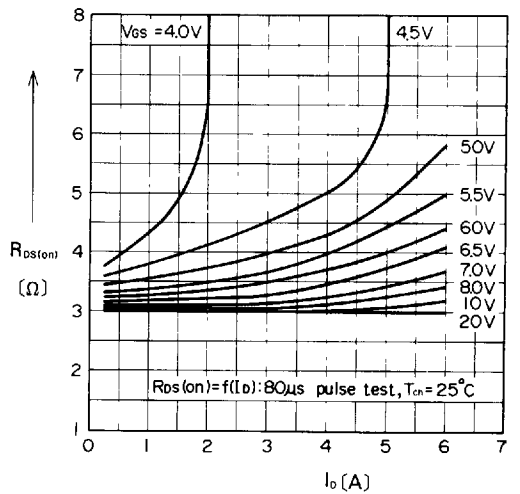

Typical Drain-Source on State Resistance vs. I_D

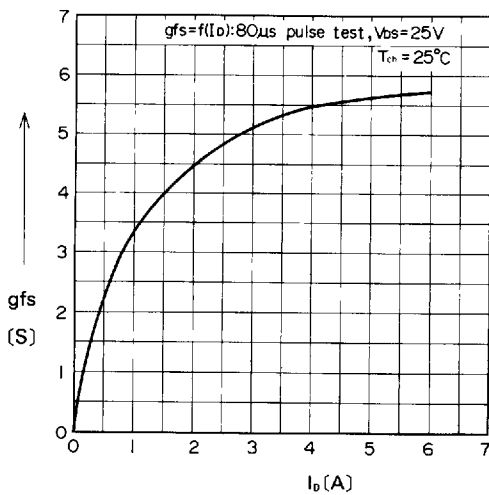

Typical Forward Transconductance vs. I_D

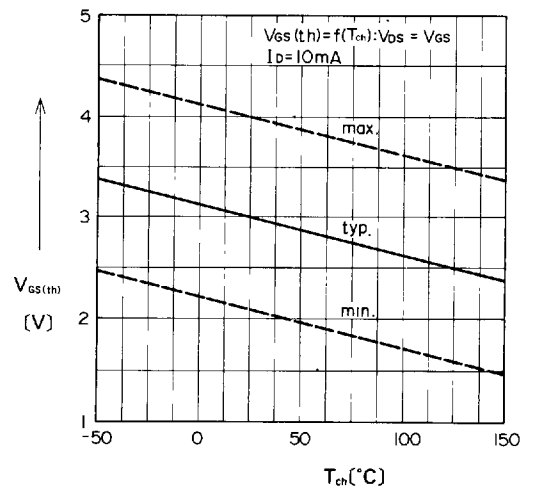

Gate Threshold Voltage vs T_{ch}

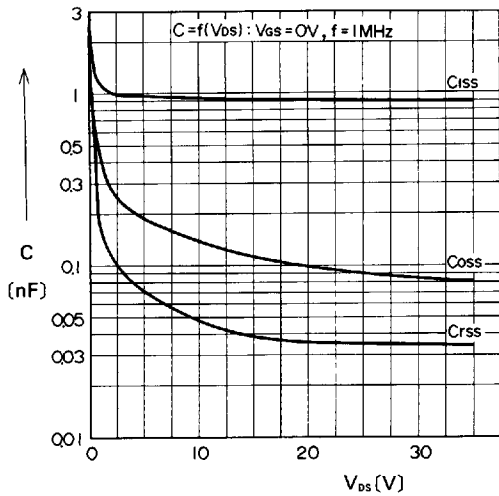

Typical Capacitance vs. V_{DS}

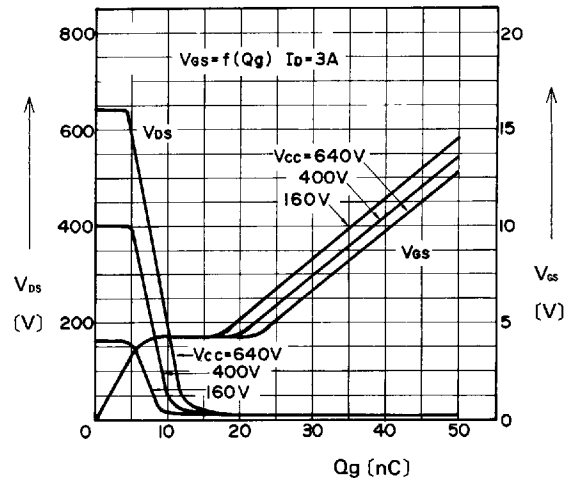

Typical Input Charge

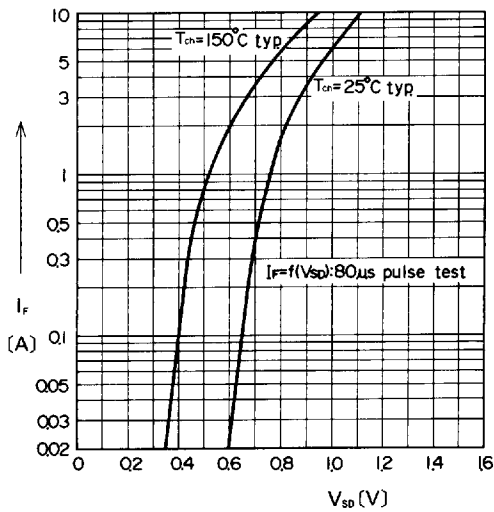

Forward Characteristics of Reverse Diode

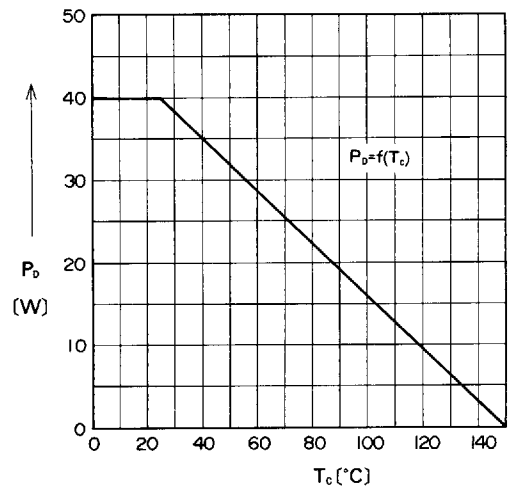

Allowable Power Dissipation vs. T_c

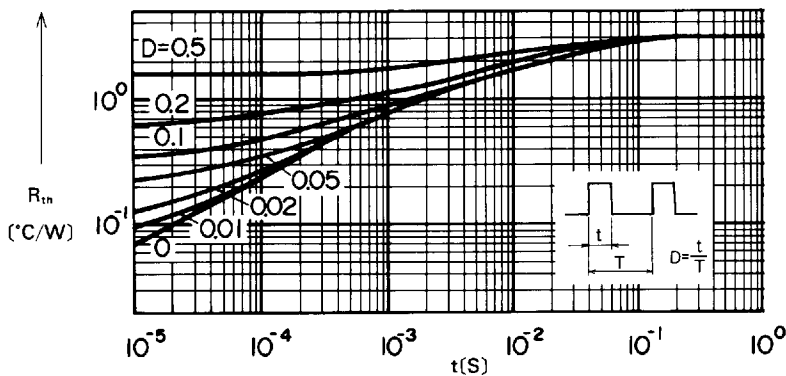

Transient Thermal Impedance

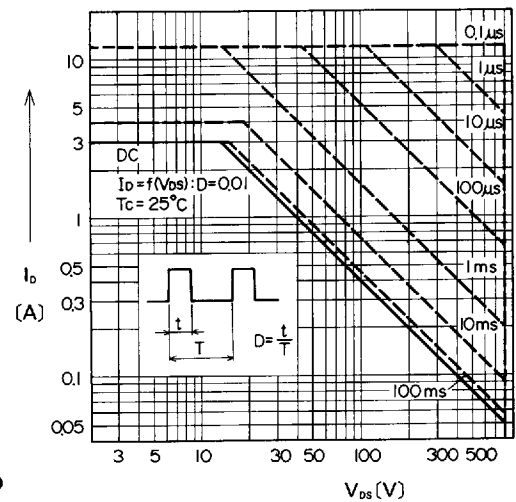

Safe Operating Area